

# **User Manual for**

**E-bike Display**

**Model YL81C-B**

# Table of Contents

1.Product name and model.....	1
2. Specifications.....	1
3.Appearance and dimensions.....	1
4. Function overview and functional area layout.....	2
4.1 Function overview.....	2
4.2 Functional area layout.....	2
4.3 Button definitions.....	2
5. General operation .....	2
5.1 Power on/off.....	2
5.2 Display interface.....	2
5.3 Push assistance.....	3
5.4 Headlight on/off.....	3
5.5 Assist level selection.....	4
5.6 Battery level indicator.....	4
5.7 Error code indicator.....	4
6. General setting.....	5
6.1 Trip distance reset.....	5
6.2 Factory reset.....	5
7. Custom setting.....	5
7.1 Rated voltage setting.....	5
7.2 Wheel diameter setting.....	6
7.3 Speed limit setting.....	6
7.4 Metric/imperial system setting.....	6
7.5 Speed sensor setting.....	7
7.6 Current limit setting.....	7
7.7 Assistance sensor setting.....	7
7.8 Power-on password setting.....	8
8. Quality commitments and warranty scope.....	8
8.1 Warranty information:.....	8
8.2 Non-warranty scope.....	8
9. Outgoing line connection diagram.....	9
9.1 Wiring sequence of standard connector.....	9
10. Considerations.....	9

### 1. Product name and model

Intelligent LCD display for e-bike; model: YL81C.

### 2. Specifications

- 36V/48V power supply
- Rated working current 15mA
- Maximum working current 30mA
- Leakage current at power-off <1uA
- Working current at the supply controller end 50mA
- Working temperature -20~60°C
- Storage temperature -30~70°C

### 3. Appearance and dimensions



Fig. 3-1 Picture of Display 81C

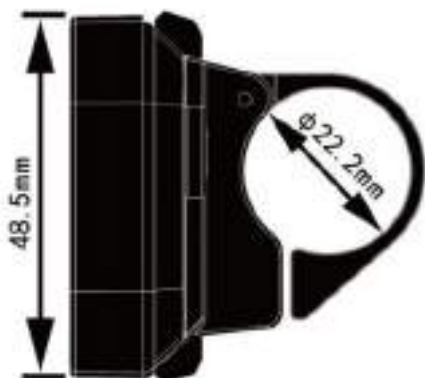

Fig. 3-2 Top View of Display 81C Dimensions

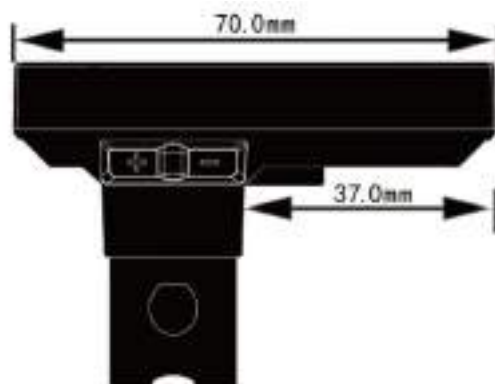

Fig. 3-3 Side View of Display 81C Dimensions

## 4. Function overview and functional area layout

### 4.1 Function overview

Display YL81C provides a variety of functions to meet the riding needs of users, including:

- Battery level indicator
- Assist level adjustment and indication
- Headlight indicator
- Speed indicator (including real-time speed, maximum speed (MAXS) and average speed (AVG))
- Distance indicator (including ODO and trip distance (Trip))
- Error code indicator
- Bluetooth connection indicator (reserved)
- Parameter setting function

### 4.2 Functional area layout

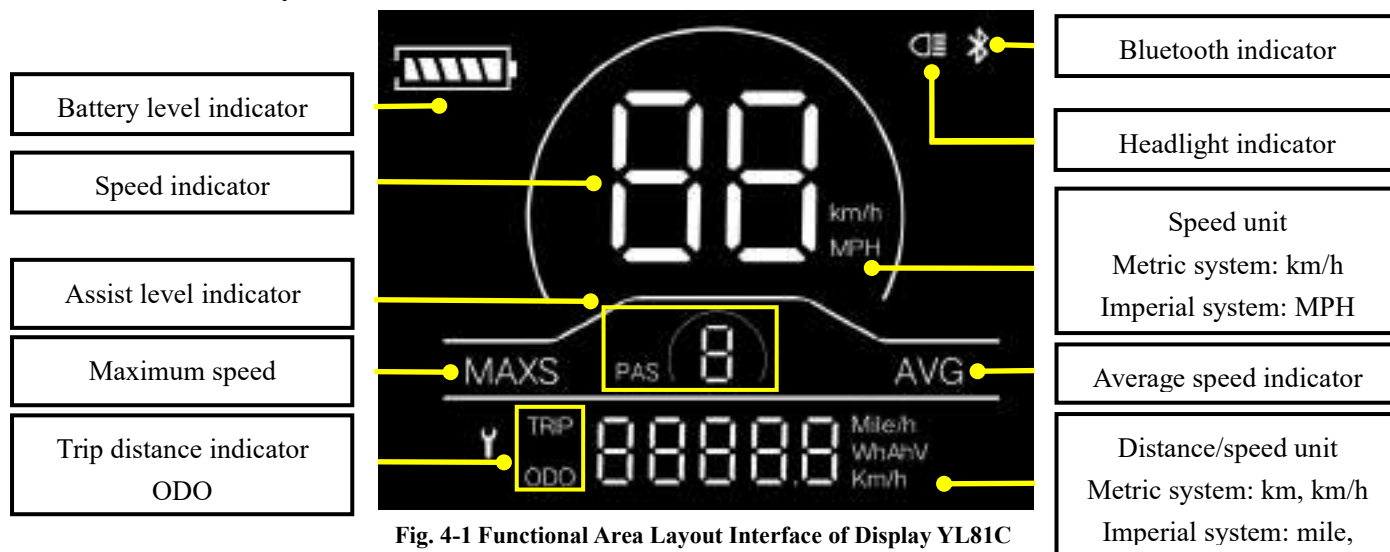







Fig. 4-1 Functional Area Layout Interface of Display YL81C

### 4.3 Button definitions

There are three buttons on the operating unit of display YL81C, i.e., the on/off button , plus button  and minus button .

## 5. General operation

### 5.1 Power on/off

By pressing and holding the button , the display will start to work and the working power supply of the controller will be turned on. In the power-on state, by pressing and holding the button , your e-bike will be powered off. In the power-off state, the display will no longer use the battery power, and its leakage current will be less than 1uA.

■ If your e-bike is not used for more than 10 minutes, the display will be automatically powered off.

### 5.2 Display interface

After the display is turned on, the display will show the real-time speed (km/h) and the trip distance (km) by default. By pressing the button , the information displayed will be switched between the trip distance (km), ODO (km), maximum speed (km/h) and average speed (km/h).

When the distance reaches 9999.9 km, it will be automatically reset to zero.

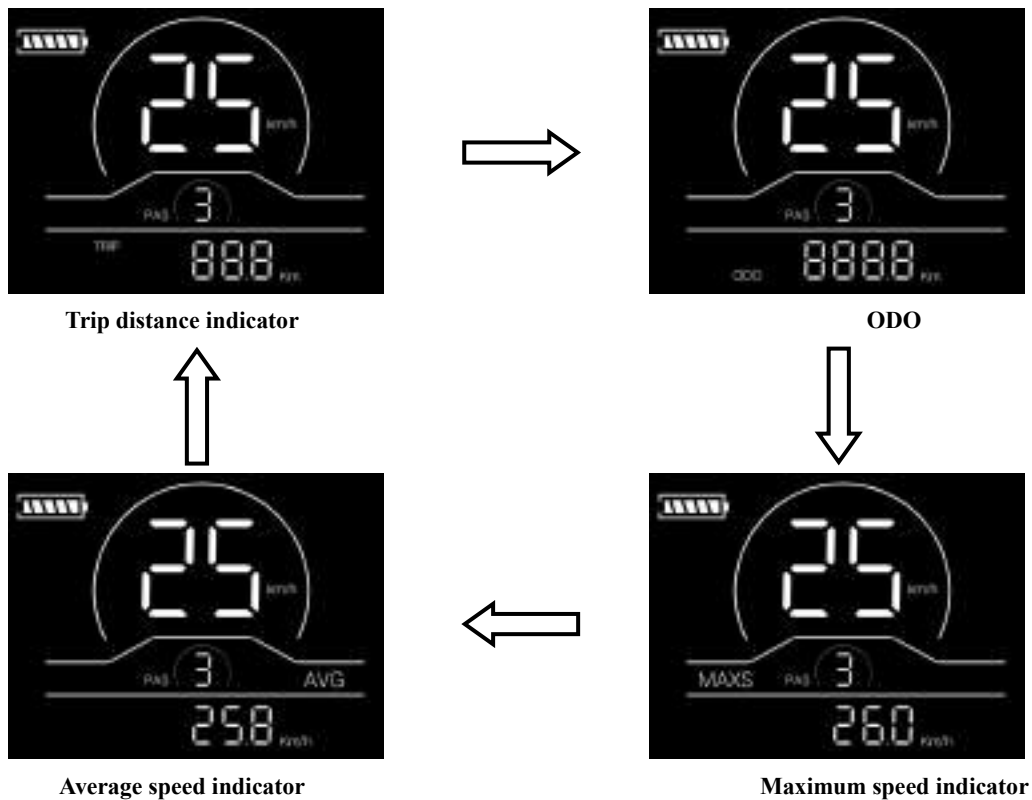

Fig. 5-1 Display Interface Switching

### 5.3 Push assistance



By pressing and holding the button , the electric push assistance mode will be enabled. Your e-bike will run at the constant speed of 6km/h. The display will show level P. By releasing the button , your e-bike will immediately stop power output and return to the state before push assistance.



Fig. 5-2 Push Assistance Indicator Interface

### 5.4 Headlight on/off



By pressing and holding the button , the controller will turn on the headlights and the display backlight will turn dark. By pressing and holding the button  again, the controller will turn off the headlights and the display backlight will resumes the luminance.



Fig. 5-3 Headlight-on Indicator Interface

### 5.5 Assist level selection



By pressing the button /, the e-bike assist level will be switched to change the motor output power. The assist levels available for the display include: levels 0-3, levels 1-3, levels 0-5, levels 1-5, levels 0-7, levels 1-7, levels 0-9 and levels 1-9.



Fig. 5-4 Assist Level Switching Interface

### 5.6 Battery level indicator

The battery level indicator consists of five segments. When the battery is fully charged, the five segments will be all on. In case of undervoltage, the outline of the battery indicator will flash, which means the battery has to be charged immediately.

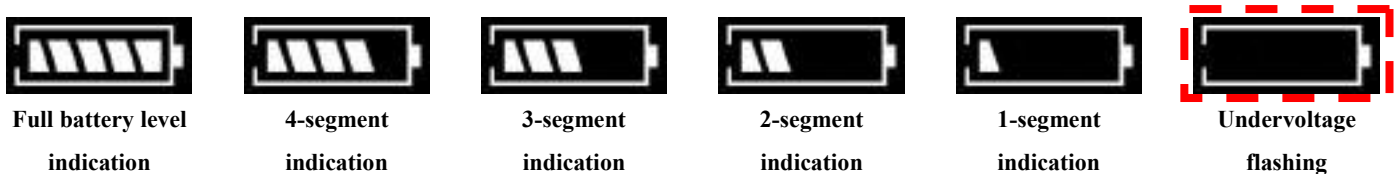

Fig. 5-5 Battery Level Indicator Interface

### 5.7 Error code indicator

When a fault occurs in the electronic control system of your e-bike, the display will automatically indicate the error code in the distance area in the format of E0\*\*. Detailed definitions of error codes are shown in **Schedule 1**.



Fig. 5-6 Error Code Indicator Interface

■ When an error code appears on the display interface, please conduct troubleshooting in time. Otherwise, your e-bike will not work normally.



## 6. General setting

- All parameters can only be set when your e-bike stops.

The steps for general setting are as follows:

In the power-on state, when the display shows the speed of 0,

### 6.1 Trip distance reset

Press and hold the buttons  and  at the same time for more than 2 seconds to reset the trip distance.

### 6.2 Factory reset



dEF refers to factory reset. dEF-n represents not to restore factory settings, and dEF-y represents to restore factory settings. Press and hold the buttons  and  at the same time for more than 2 seconds to enter the factory reset interface, and press the button  to select a parameter.





Fig. 6-1 Factory Reset Interface



## 7. Custom setting

- All parameters can only be set when your e-bike stops.

The steps for custom setting are as follows:

In the power-on state, when the display shows the speed of 0,

(1) Press and hold the buttons  and  at the same time for more than 2 seconds to enter the selection interface of custom setting options;

(2) Press the button  to switch the selection interface of general setting options, and press the button  to enter the parameter modification interface;

(3) Press the button  /  for parameter selection;

(4) Press  button to save the parameter and return to the selection interface of custom setting options;

(5) Press and hold the button  to save the parameter and exit the selection interface of custom setting options.

### 7.1 Rated voltage setting



P1 refers to the rated voltage setting option. Available values include: 36V and 48V. Press the button  to enter the parameter modification interface. Press the button  for parameter selection. Press the button  to save the parameter and return to the selection interface of general setting options.



Fig. 7-1 Rated Voltage Setting Interface

## 7.2 Wheel diameter setting



P2 refers to the wheel diameter setting option. Available parameters include: 8-32 inches. Press the button  to enter the parameter modification interface. Press the button  for parameter selection. Press the button  to save the parameter and return to the selection interface of general setting options.



Fig. 7-2 Wheel Diameter Setting Interface

## 7.3 Speed limit setting







P3 represents the speed limit setting option. The adjustable range is 10~40km/h. Press the button  to enter the parameter modification interface. Press the button  for parameter selection. Press the button  to save the parameter and return to the selection interface of general setting options.



Fig. 7-3 Speed Limit Setting Interface

## 7.4 Metric/imperial system setting

P4 refers to the metric/imperial system setting option. 00 represents the metric system, and 01 represents the imperial system. Press the button  to enter the parameter modification interface. Press the button  for parameter selection. Press the button  to save the parameter and return to the selection interface of general setting options.





Metric system indicator interface



Imperial system indicator interface

Fig. 7-4 Metric/imperial System Setting Interface

### 7.5 Speed sensor setting



P5 refers to the speed sensor setting option, which can be set according to the number of magnetic heads installed on the wheels of your e-bike. The setting range is 1-63. Press the button  to enter the parameter modification interface. Press the button  for parameter selection. Press the button  to save the parameter and return to the selection interface of general setting options.



Fig. 7-5 Speed Sensor Setting Interface

### 7.6 Current limit setting



P6 refers to current limit setting. The adjustable range is 1-25A. Press the button  to enter the parameter modification interface. Press the button  for parameter selection. Press the button  to save the parameter and return to the selection interface of general setting options.



Fig. 7-6 Current Limit Setting Interface

### 7.7 Assistance sensor setting







P7 refers to the assistance sensor setting option, where the number of steel magnets of the assistance magnetic disk can be set. The adjustable range is 5, 6, 7, 8, 9, 10 and 12. Press the button  to enter the parameter modification interface. Press the button  for parameter selection. Press the button  to save the parameter and return to the selection interface of general setting options.



Fig. 7-7 Assistance Sensor Setting Interface

## 7.8 Power-on password setting

P8 refers to the power-on password setting option. PSd-Y means that a power-on password is required, and PSd-N means that no power-on passwords are required. The default value of the display is PSd-N. Press the button  to enter the modification interface, and press the button  /  to enter the selection interface.

If PSd-N is selected, press the button  to return to the selection interface of custom setting options;





If PSd-Y is selected, press the button  to enter the password setting interface. If you don't want to change the password, press and hold the button  to exit the custom setting interface. If you want to change the password, press the button  for cursor movement and the button  for figure selection, and then press the button  to return to the selection interface of custom setting options.



Fig. 7-8 Power-on Password Setting Interface

## 8. Quality commitments and warranty scope

### 8.1 Warranty information:

- For the faults caused by the quality of the product under normal use, the Company will be responsible for providing limited warranty during the warranty period.

- The warranty period of the product is within 12 months from delivery.

### 8.2 Non-warranty scope

- The enclosure is opened
- The connector is damaged
- The enclosure is scratched or damaged after delivery
- The outgoing line of the display is scratched or broken
- Faults or damage caused by force majeure (such as fires, earthquakes, etc.) or natural disasters (such as lightning strikes, etc.)
- The warranty period has expired

## 9. Outgoing line connection diagram

### 9.1 Wiring sequence of standard connector

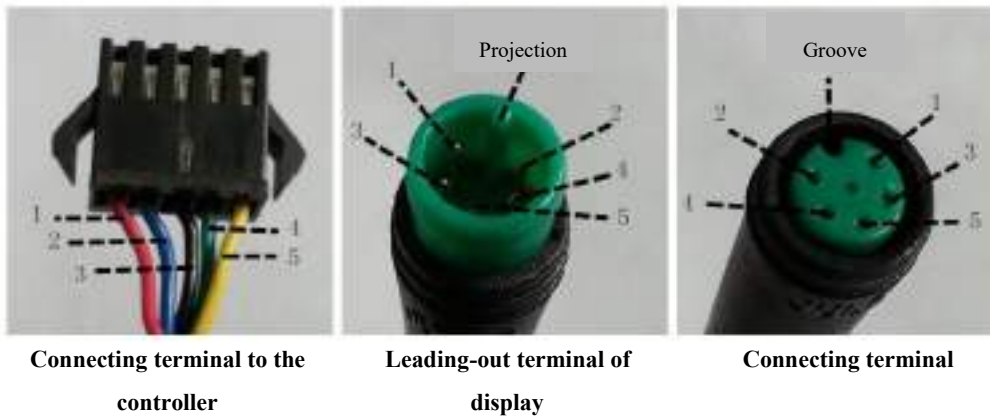

Fig. 9-1 Outgoing Line Connection Diagram

Table 9-1 Wiring Sequence of Standard Connector

Standard wiring sequence	Standard wire color	Function
1	Red (VCC)	Power cord of display
2	Blue (Kp)	Power control line of controller
3	Black (GND)	Ground wire of display
4	Green (RX)	Data receiving line of display
5	Yellow (TX)	Data transmission line of display

■ The outgoing lines of some products adopt waterproof connectors, and users cannot see the outgoing line color inside the wire harnesses.

## 10. Considerations

Please use safely, and do not plug or unplug the display when it is powered on.

◆ Please avoid bumping as far as possible.

◆ Please do not alter the background parameter settings of the display at will, otherwise normal riding cannot be guaranteed.

◆ If the display fails to work normally, it should be repaired as soon as possible.

◆ Due to product upgrades of the Company, part of the displayed contents or functions of the product you bought may be different from the manual, depending on the actual model.

### Schedule 1 Error Code Definitions

Error codes for protocols YL-01 and YL-02:			
Error codes	Definition		Error codes
			Definition
E001	Controller Abnormality		E004
E002	Communication Abnormality		E005
E003	Motor Hall Signal Abnormality		E006
			Throttle Abnormality
			Brake Abnormality
			Motor Phase Abnormality
Error codes for protocols YL-05, KDS and YL-J:			
Error codes	Definition		Error codes
			Definition
E021	Current Abnormality		E024
E022	Throttle Abnormality		E025
E023	Motor Phase Abnormality		E030
			Motor Hall Signal Abnormality
			Brake Abnormality
			Communication Abnormality