

### Bike Components

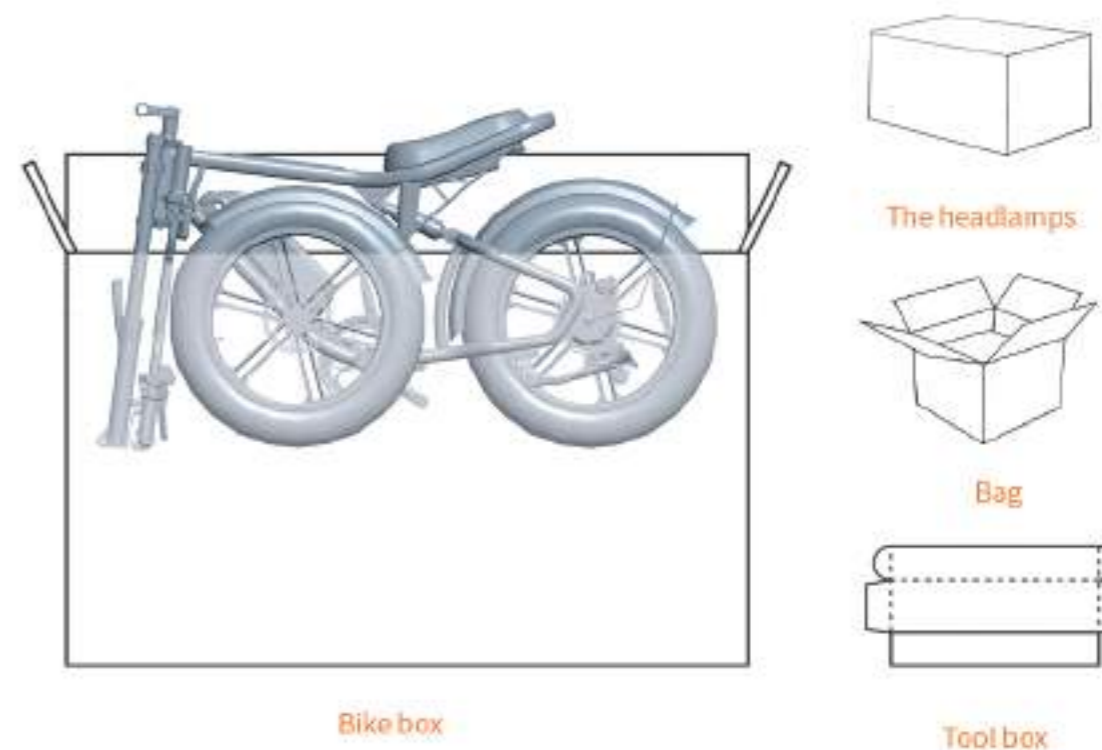

Performance index	Project	M20
Basic Parameters	Vehicle Size	1640*700*1130
	wheel Size	20Inches
	Body Material	Aluminium alloy
	Maximum Load	264.5 lbs(120KG)
	Vehicle weight	75lbs(34KG)
Main Parameters of the Whole Vehicle	Maximum Speed	28mph(45km/h)
	Maximum Gradient	10°
	Rear Derailleur	7-Speed
	Mileage Range	28 miles(45km)
	Working Temperature	23°F-95°F(-5 ~35 )
Battery Parameters	Rated Voltage	48V
	Battery Capacity	13AH
	Service Life	500 Times
Motor Parameters	Motor Power	750W
	Motor Type	Brushless Gear Motor
	Maximum Torque	55Nm
Charger Parameters	Input voltage	100-240V
	output voltage	54V
	Output Current	2A

- (1)Take out the bike, the seatpost, and the tool box.
- (2)Remove (and recycle) all wrapping material.
- (3) Save the bike box and tool box for future use.





(1) Take out the front wheel.

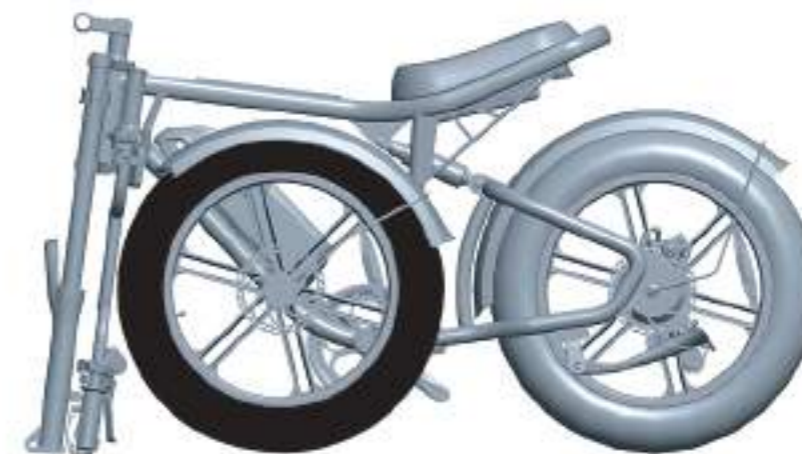

(2) Remove the foam from both sides of the front wheel.



Dismantle the foam, and then rotate the instrument to the top of the handlebar.



(1) Dismantle the foam, and then rotate the instrument to the top of the handlebar.



(2) Place the handlebar at an appropriate position, make sure the "cross symbol" is located at the center.

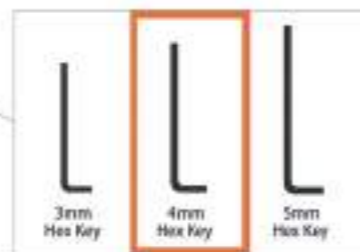

(3) Use a 4mm hex key to install the 4 bolts by turning clockwise. The sequence is shown in the picture above. Please do not fully tighten them yet.

(4) Once the bolts and the handlebar are in the right place, tighten the bolts fully with appropriate force.



## Install the front light



- (1) Take the headlight out of the carton.
- (2) Please follow the steps below to assemble the headlamp.



## Install the front wheel



 This step is extremely important, so please read carefully.

- (1)The front axle is assembled according to the following steps.



- (2)Clamp the front wheel with the front fork and lock the front wheel screw with a wrench.



## Install the fender



(1) Install as shown in the figure below.

The lifting lug of the mud pan is connected with the hole of the front fork axle pipe, and then threaded in the screw to tighten it.

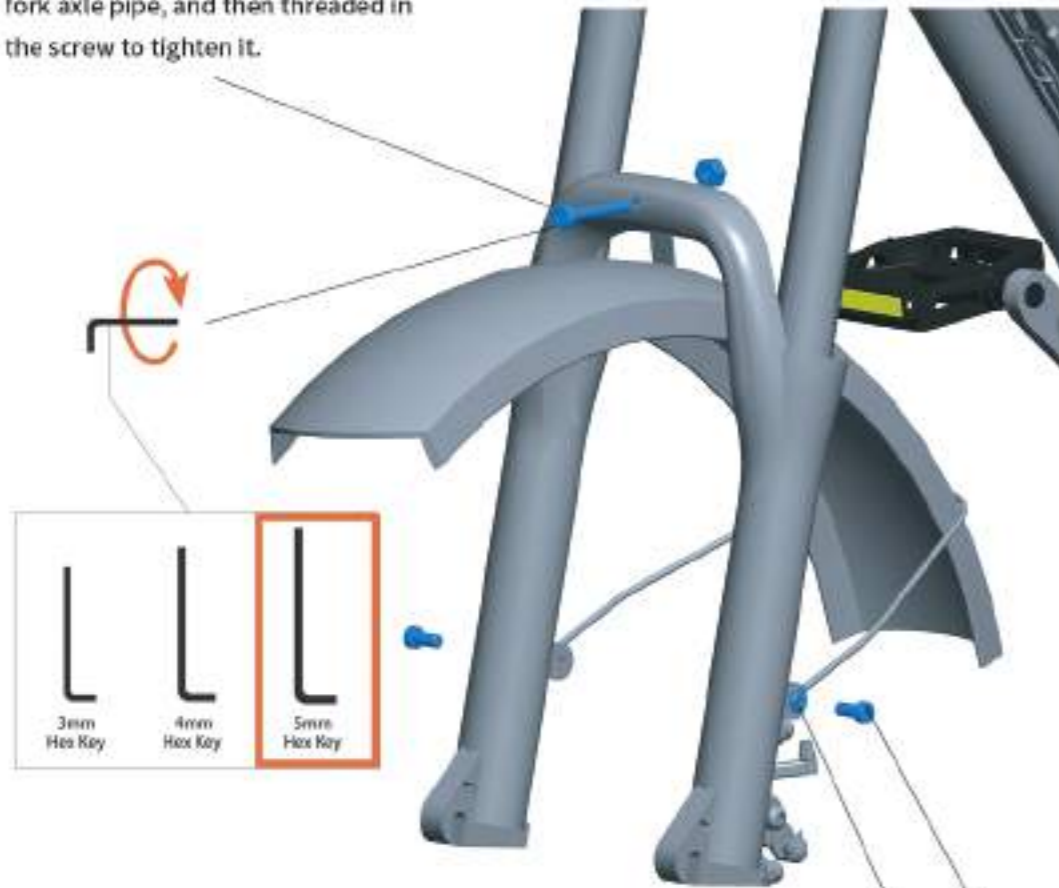

The mudguard support shall be aligned with the front fork mudguard take-up hole position, and then threaded into the screw for tightening.

## Install the pedals



(1) The pedals are marked with "R" (Right) and "L" (Left).

This refers to the two sides of the e-bike. The R pedal goes to the side of the carbon belt, and the L pedal goes to the other side.



(2) Manually install the left pedal by turning counterclockwise. Tighten the pedal securely with a 15mm wrench.

(3) Manually install the right pedal by turning clockwise. Tighten the pedal securely with a 15mm wrench.

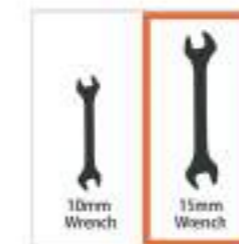



## 1. Function overview and functional area layout

### 1.1 Function overview

Display M20 provides a variety of functions to meet the riding needs of users, including:

- Battery level indicator
- Assist level adjustment and indication
- Headlight indicator
- Speed indicator (including real-time speed, maximum speed (MAXS) and average speed (AVG))
- Distance indicator (including ODO and trip distance (Trip))
- Error code indicator
- Bluetooth connection indicator (reserved)
- Parameter setting function

### 1.2 Functional area layout





Fig. 1-1 Functional Area Layout Interface of Display M20

### 1.3 Button definitions

There are three buttons on the operating unit of display M20, i.e., the on/off button , plus button  and minus button .

## 2. General operation

### 2.1 Power on/off

By pressing and holding the button , the display will start to work and the working power supply of the controller will be turned on. In the power-on state, by pressing and holding the button , your e-bike will be powered off. In the power-off state, the display will no longer use the battery power, and its leakage current will be less than 1uA.

■ If your e-bike is not used for more than 10 minutes, the display will be automatically powered off.

### 2.2 Display interface

After the display is turned on, the display will show the real-time speed (km/h) and the trip distance (km) by default.

By pressing the button , the information displayed will be switched between the trip distance (km), ODO (km), maximum speed (km) and average speed (km).

When the distance reaches 9999.9 km, it will be automatically reset to zero.

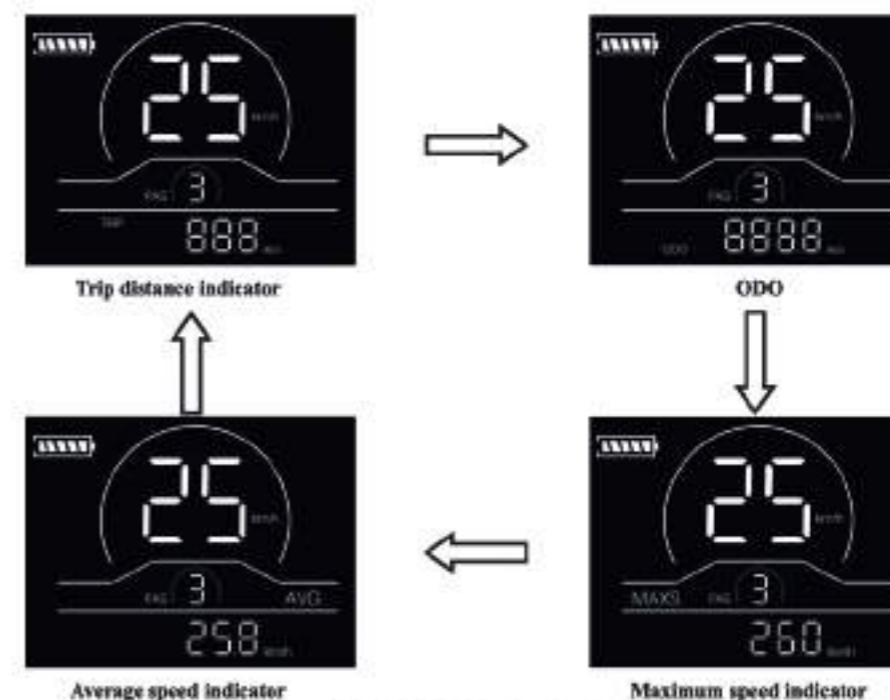

Fig. 2-1 Display Interface Switching

### 2.3 Push assistance



By pressing and holding the button , the electric push assistance mode will be enabled. Your e-bike will run at the constant speed of 6km/h. The display will show level P. By releasing the button , your e-bike will immediately stop power output and return to the state before push assistance.



Fig. 2-2 Push Assistance Indicator Interface

### 2.4 Assist level selection



By pressing the button  or , the e-bike assist level will be switched to change the motor output power. The assist levels available for the display include: levels 0-3, levels 1-3, levels 0-5, levels 1-5, levels 0-7, levels 1-7, levels 0-9 and levels 1-9.



Fig. 2-3 Assist Level Switching Interface

## 2.5 Battery level indicator

The battery level indicator consists of five segments. When the battery is fully charged, the five segments will be all on. In case of undervoltage, the outline of the battery indicator will flash, which means the battery has to be charged immediately.

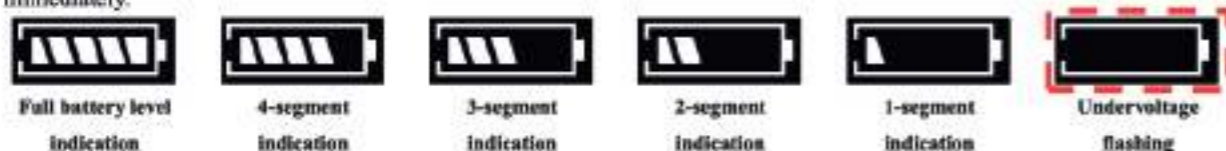

Fig. 2-4 Battery Level Indicator Interface

## 2.6 Error code indicator

When a fault occurs in the electronic control system of your e-bike, the display will automatically indicate the error code in the distance area in the format of E00\*. Detailed definitions of error codes are shown in Schedule 1.



Fig. 2-5 Error Code Indicator Interface

■ When an error code appears on the display interface, please conduct troubleshooting in time. Otherwise, your e-bike will not work normally.



## 3. General setting

■ All parameters can only be set when your e-bike stops.

The steps for general setting are as follows:

In the power-on state, when the display shows the speed of 0,

### 3.1 Trip distance reset

Press and hold the buttons  and  at the same time for more than 2 seconds to reset the trip distance.

### 3.2 Factory reset

DEF refers to factory reset. dEF-n represents not to restore factory settings, and dEF-y represents to restore factory settings.



Press and hold the buttons  and  at the same time for more than 2 seconds to enter the factory reset interface, and press the button  to select a parameter.





Fig. 3-1 Factory Reset Interface



## 4. Custom setting

■ All parameters can only be set when your e-bike stops.

The steps for custom setting are as follows:

In the power-on state, when the display shows the speed of 0,

(1) Press and hold the buttons  and  at the same time for more than 2 seconds to enter the selection interface of custom setting options;

(2) Press the button  to switch the selection interface of general setting options, and press the button  to enter the parameter modification interface;

(3) Press the button  for parameter selection;

(4) Press the button  to save the parameter and return to the selection interface of custom setting options;

(5) Press and hold the button  to save the parameter and exit the selection interface of custom setting options.

### 4.1 Rated voltage setting



P1 refers to the rated voltage setting option. Available values include: 36V and 48V. Press the button  to enter the parameter modification interface. Press the button  for parameter selection. Press the button  to save the parameter and return to the selection interface of general setting options.



Fig. 4-1 Rated Voltage Setting Interface

### 4.2 Wheel diameter setting



P2 refers to the wheel diameter setting option. Available parameters include: 8-32 inches. Press the button  to enter the parameter modification interface. Press the button  for parameter selection. Press the button  to save the parameter and return to the selection interface of general setting option.



Fig. 4-2 Wheel Diameter Setting Interface



#### 4.3 Speed limit setting







P3 represents the speed limit setting option. The adjustable range is 10-60km/h. Press the button  to enter the parameter modification interface. Press the button  for parameter selection. Press the button  to save the parameter and return to the selection interface of general setting options.



Fig. 4-3 Speed Limit Setting Interface

#### 4.4 Metric/imperial system setting

P4 refers to the metric/imperial system setting option. 00 represents the metric system, and 01 represents the imperial system. Press the button  to enter the parameter modification interface. Press the button  for parameter selection. Press the button  to save the parameter and return to the selection interface of general setting options.



Metric system indicator interface



Imperial system indicator interface

Fig. 4-4 Metric/imperial System Setting Interface

#### 4.5 Speed sensor setting



P5 refers to the speed sensor setting option, which can be set according to the number of magnetic heads installed on the wheels of your e-bike. The setting range is 1-63. Press the button  to enter the parameter modification interface. Press the button  for parameter selection. Press the button  to save the parameter and return to the selection interface of general setting options.



Fig. 4-5 Speed Sensor Setting Interface

#### 4.6 Current limit setting



P6 refers to current limit setting. The adjustable range is 1-25A. Press the button  to enter the parameter modification interface. Press the button  for parameter selection. Press the button  to save the parameter and return to the selection interface of general setting options.



Fig. 4-6 Current Limit Setting Interface

#### 4.7 Assistance sensor setting







P7 refers to the assistance sensor setting option, where the number of steel magnets of the assistance magnetic disk can be set. The adjustable range is 5, 6, 7, 8, 9, 10 and 12. Press the button  to enter the parameter modification interface. Press the button  for parameter selection. Press the button  to save the parameter and return to the selection interface of general setting options.



Fig. 4-7 Assistance Sensor Setting Interface

#### 4.8 Power-on password setting

P8 refers to the power-on password setting option. PSD-Y means that a power-on password is required, and PSD-N means that no power-on passwords are required. The default value of the display is PSD-N. Press the button  to enter the modification interface, and press the button  to enter the selection interface.

If PSD-N is selected, press the button  to return to the selection interface of custom setting options;





If PSD-Y is selected, press the button  to enter the password setting interface. If you don't want to change the password, press and hold the button  to exit the custom setting interface. If you want to change the password, press the button  for cursor movement and the button  for figure selection, and then press the button  to return to the selection interface of custom setting options.



Fig. 4-8 Power-on Password Setting Interface

## 5. Considerations

Please use safely, and do not plug or unplug the display when it is powered on.

- ◆ Please avoid bumping as far as possible.
- ◆ Please do not alter the background parameter settings of the display at will, otherwise normal riding cannot be guaranteed.
- ◆ If the display fails to work normally, it should be repaired as soon as possible.
- ◆ Due to product upgrades of the Company, part of the displayed contents or functions of product you bought may be different from the manual, depending on the actual model.

**Schedule 1 Error Code Definitions**

Error codes	Definition	Error codes	Definition
E021	Current Abnormality	E024	Motor Hall Signal Abnormality
E022	Throttle Abnormality	E025	Brake Abnormality
E023	Motor Phase Abnormality	E030	Communication Abnormality

- How far full charge battery can go?That depends on the loading weight,road condition and battery capacity.But in the same condition,average speeds can continuous longer travel range.

- When storing the battery for a longer time,(during winter time)it is important to place the fully charged battery in a dry place.

- Attention:The battery should be re-charged once every 2-3 month when it is not used.

### WARNING:

- Keep the battery out of reach for children.
- Never try to open the battery.
- Only use the ENGWE supplied battery.Do not use a battery from any other different product models.
- If the battery is damaged because it has been dropped somewhere or biking accident,there may be a risk of electrolytes leakage.Beware of chemical burns! And immediately stop using the damaged battery.
- Do not touch the battery without a cloth or gloves and make sure no acid touches your eyes.
- Do not store the battery in temperatures above 95F or below 23° F.
- Do not allow the battery to run down completely before charging.Charge the battery before storing the product.If the battery is completely empty,it may cause the battery to no longer charge.
- Charge a new battery for at least 4-6 hours before you use it in your product for the first time.Never charge the battery too long per time.Overheating or undercharging the battery may shorten battery life and decrease product run time.



### IMPORTANT:BATTERY DISPOSAL

- Battery must be recycled or disposed of in an environmentally sound manner.
- Do not dispose of the battery in a fire.The battery may explode or leak.
- Do not dispose of a battery in your regular household trash.



## Charging



How far full charge battery can go? That depends on the loading weight, road condition and battery capacity. But in the same condition, average speeds can continuous longer travel range.

- You can charge the bike directly, or you can remove the battery for charging.
- The RED light indicates it is in charging and GREEN light indicates the battery is fully charged. (Please put off plug from wall) Usually the charging time is 4-6 hours depends on the battery capacity remain.

### **WARNING:**

- Charging time over 10 hours is prohibited please kept it away from high temperature environment and stores it in a cool place.
- Please make sure that the battery charger and charging plug are always kept dry and never get wet.
- The charger should only be cleaned with a dry cloth. Never use a wet cloth, oil or any other liquid.
- Do not connect positive and negative terminals.
- Stop the charging procedure immediately if you notice anything unusual.
- It is strictly forbidden to cut the battery charging and discharging lines.
- It is strictly forbidden to disassemble the battery box or modify the internal structure and protection board of the lithium battery.
- It is strictly forbidden to disassemble the battery box or modify the internal structure and protection board of the lithium battery.
- Only use the ENGWE supplied charger. Do not use a charger from any other different product models.
- After using the battery, please charge it within 12 hours.

If the product has problems with the following forms during the protection period, we will provide customer service as part of the product quality guarantee.

## Charging



● How far full charge battery can go? That depends on the loading weight, road condition and battery capacity. But in the same condition, average speeds can continuous longer travel range.

- When storing the battery for a longer time, (during winter time) it is important to place the fully charged battery in a dry place.
- Attention: The battery should be re-charged once every 2-3 month when it is not used.

### **WARNING:**

- Keep the battery out of reach for children.
- Never try to open the battery.
- Only use the ENGWE supplied battery. Do not use a battery from any other different product models.
- If the battery is damaged because it has been dropped somewhere or biking accident, there may be a risk of electrolytes leakage. Beware of chemical burns! And immediately stop using the damaged battery.
- Do not touch the battery without a cloth or gloves and make sure no acid touches your eyes.
- Do not store the battery in temperatures above 95F or below 23° F.
- Do not allow the battery to run down completely before charging. Charge the battery before storing the product. If the battery is completely empty, it may cause the battery to no longer charge.
- Charge a new battery for at least 4-6 hours before you use it in your product for the first time. Never charge the battery too long per time. Overheating or undercharging the battery may shorten battery life and decrease product run time.



Accessories	quality problem	Warranty period	service content
Motor	Motor will not be able to use	1year	Free delivery of parts
Accelerator	Natural conditions(such as impact force cannot be used except damage)	1year	Free delivery of parts
Controller	Failure occurs under normal use	1year	Free delivery of parts
Charger	Failure occurs under normal use	1 year	Free delivery of parts
Lithium Battery	Can't charge discharge under normal use	1 year	Free delivery of parts

**Notes:**

If the above issues occur during the protection period, please contact us and send us photos or videos of the defective parts. If we confirm that the fault is caused by the quality of the product itself, we will send you the parts that are needed replaced for free.

**Year Limited Hardware Warranty**

Your ENGWE Electric bike includes a One Year Limited Hardware Warranty.The Warranty covers product defects in materials and workmanship under normal use.This Warranty is limited to original purchasers.This Warranty starts on the date of your purchase and lasts for one year(the "Warranty Period").The Warranty Period is not extended if the Product is repaired or replaced.

Warranty services are provided by the e-bike.If a hardware defect arises and a valid claim is received within the Warranty Period,at its option and to the extent permitted by law,ENGWE will resend new parts that are equivalent to new in performance and reliability.This Warranty is not assignable or transferable.The original purchaser may contact us for service request.

This Warranty does not cover any damage due to:improper use;failure to follow the product instructions or to perform any preventive maintenance;unauthorized repair; external causes such as accidents,abuse,or other actions or events beyond our reasonable control.

**Any question about the item,please contact the customer service from where you brought your device.**